

75 AMP 24 VOLT PRESS FIT TVS DIODES

MECHANICAL DATA

- VOID FREE VACUUM DIE SOLDERING FOR MAXIMUM MECHANICAL STRENGTH AND HEAT DISSIPATION (Solder Voids: Typical $\leq 2\%$, Max. $\leq 10\%$ of Die Area)
- LARGE DIE FOR HIGH POWER HEAVY DUTY PERFORMANCE
- HIGH HEAT HANDLING CAPABILITY WITH VERY LOW THERMAL STRESS
- PROPRIETARY JUNCTION PASSIVATION FOR SUPERIOR RELIABILITY AND PERFORMANCE
- LOW FORWARD VOLTAGE DROP

MECHANICAL DATA

- Case: Nickel plated copper
- Finish: All external surfaces are corrosion resistant and the contact areas are readily solderable
- Soldering Temperature: 210 °C maximum
- Mounting Position: Any. Maximum force used for diode insertion to be 12 KN
- Polarity: Color coded epoxy ring.
 ANODE on LEAD (Beige Ring):part number=TVS7524PFA.
 CATHODE on LEAD (Black Ring):Part No.=TVS7524PFC.
 Part No. marked on cap base.

MECHANICAL SPECIFICATION

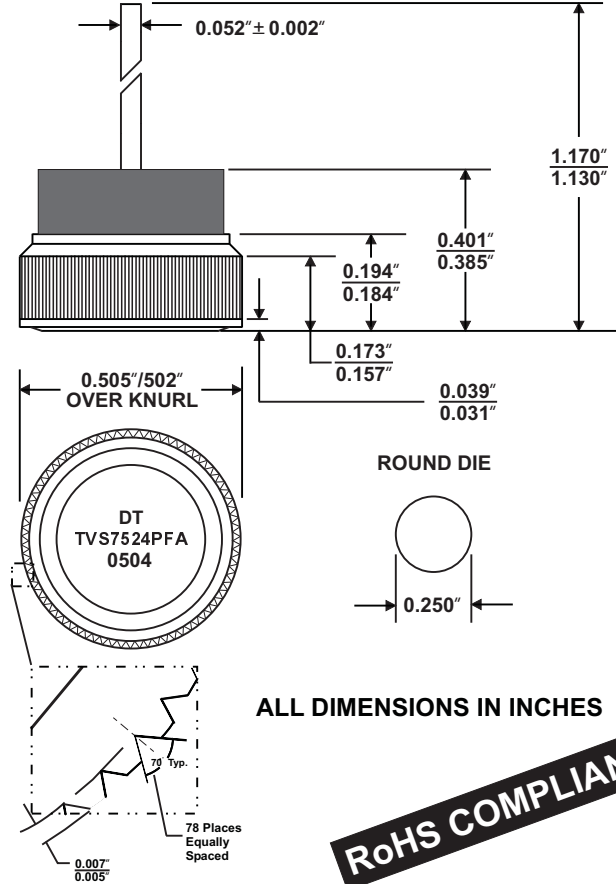

ALL DIMENSIONS IN INCHES

RoHS COMPLIANT

MAXIMUM RATINGS & ELECTRICAL CHARACTERISTICS

Ratings at 25 °C ambient temperature unless otherwise specified.

PARAMETER (TEST CONDITIONS)	SYMBOL	RATINGS		UNITS
		TVS7524PFC	TVS7524PFA	
Series Number				
Maximum Recurrent Peak Reverse Voltage	VRRM	23	23	VOLTS
Working Peak Reverse Voltage	VRWM			
Maximum DC Blocking Voltage	VDC			
Breakdown Voltage (IR = 100 mA dc, Tc = 25 °C)	V(BR)	24 Min / 32 Max	24 Min / 32 Max	
Average Forward Rectified Current	IO	75	75	AMPS
Non-repetitive Peak Forward Surge Current (Half wave, single phase, 60 Hz sine applied to rated load)	IFSM	800	800	
Repetitive Peak Reverse Surge Current (Time Constant = 10 mSec Duty Cycle $\leq 1.0\%$, Tc = 25 °C)	IRSM	150	150	
Instantaneous Forward Voltage (IF = 100A@ 300 μ Secpulse, Tc = 25 °C)	VF	1.05	1.05	VOLTS
Maximum DC Reverse Current (VR = 20V DC, Tc = 25 °C)		IR	200	
Maximum Thermal Resistance, Junction to Case	R _{θJC}	0.50	0.50	°C/W
Junction Operating & Storage Temperature Range	TJ, TSTG	-65 to +215	-65 to +215	°C

2331w7524p