

HIGH VOLTAGE DIODE RECTIFIERS

FEATURES

- PROPRIETARY **SOFT GLASS[®]** JUNCTION PASSIVATION FOR SUPERIOR RELIABILITY AND PERFORMANCE
- VOID FREE VACUUM DIE SOLDERING FOR MAXIMUM MECHANICAL STRENGTH AND HEAT DISSIPATION (Solder Voids: Typical $\leq 2\%$, Max. $\leq 10\%$ of Die Area)
- EXTREMELY LOW LEAKAGE AT HIGH TEMPERATURES
- LOW FORWARD VOLTAGE DROP
- HIGH CURRENT CAPABILITY

MECHANICAL DATA

- Case: JEDEC DO-41 molded epoxy (U/L Flammability Rating 94V-0)
- Terminals: Plated axial leads
- Soldering: Per MIL-STD 202 Method 208 guaranteed
- Polarity: Color band denotes cathode
- Mounting Position: Any
- Weight: DO-41 - 0.012 Ounces (0.34 Grams)

RoHS COMPLIANT

MECHANICAL SPECIFICATION

ACTUAL SIZE OF DO-41 PACKAGE

SERIES GP1120 - GP1500

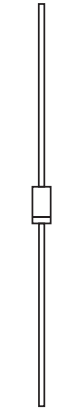

DO-41

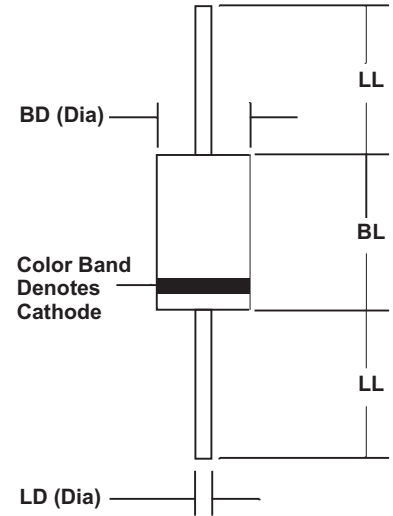

Sym	Minimum		Maximum	
	In	mm	In	mm
BL	0.160	4.1	0.205	5.2
BD	0.103	2.6	0.107	2.7
LL	1.00	25.4		
LD	0.028	0.71	0.034	0.86

MAXIMUM RATINGS & ELECTRICAL CHARACTERISTICS

Ratings at 25 °C ambient temperature unless otherwise specified.
 Single phase, half wave, 60Hz, resistive or inductive load.
 For capacitive loads, derate current by 20%.

PARAMETER (TEST CONDITIONS)	SYMBOL	RATINGS										UNITS
		GP 1150	GP 1180	GP 1200	GP 1250	GP 1300	GP 1400	GP 1500	GP 1600			
Series Number												
Maximum DC Blocking Voltage	V _{RM}	1500	1800	2000	2500	3000	4000	5000	6000			VOLTS
Maximum RMS Voltage	V _{RMS}	1050	1260	1400	1750	2100	2800	3500	4200			
Maximum Peak Recurrent Reverse Voltage	V _{RRM}	1500	1800	2000	2500	3000	4000	5000	6000			
Average Forward Rectified Current @ T _A = 50 °C, Lead length = 0.375 in. (9.5 mm)	I _O	1000			500			200				mA
Peak Forward Surge Current (8.3 mSec single half sine wave superimposed on rated load)	I _{FSM}	35			25			15				AMPS
Maximum Forward Voltage at Rated Forward Current	V _{FM}	1.5			3.0			4.5	6.0			VOLTS
Maximum Average DC Reverse Current At Rated DC Blocking Voltage @ T _A = 25°C	I _{RM}	1.0										μA
Typical Junction Capacitance (Note 1)	C _J	12										pF
Operating and Storage Temperature Range	T _J , T _{STG}	-65 to +150										°C

NOTES: (1) Measured at 1MHz & applied reverse voltage of 4 volts

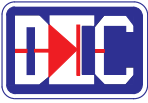

HIGH VOLTAGE DIODE RECTIFIERS

RATING & CHARACTERISTIC CURVES FOR SERIES GP1150 - GP1600

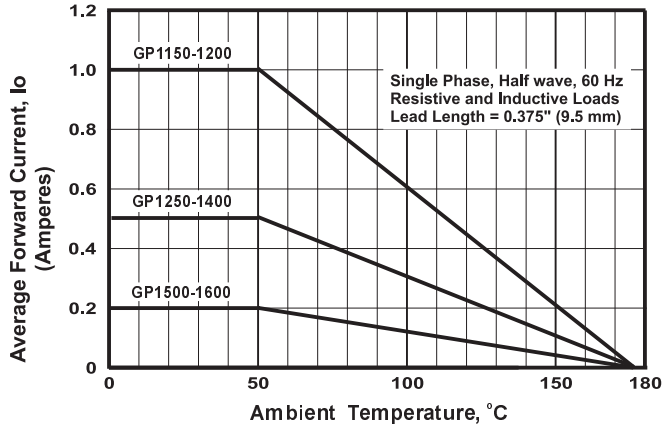

FIGURE 1. FORWARD CURRENT DERATING CURVE

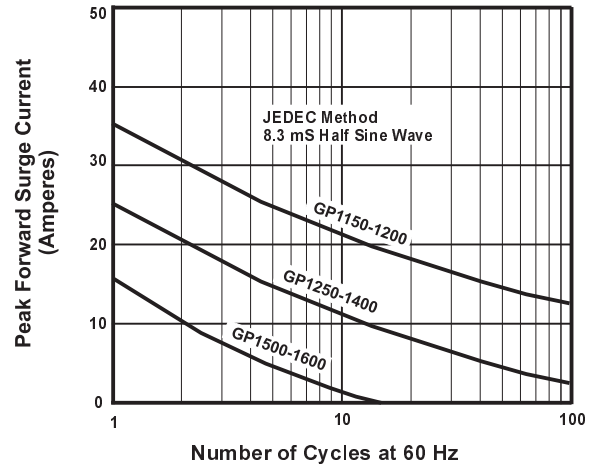

FIGURE 2. MAXIMUM NON-REPETITIVE SURGE CURRENT

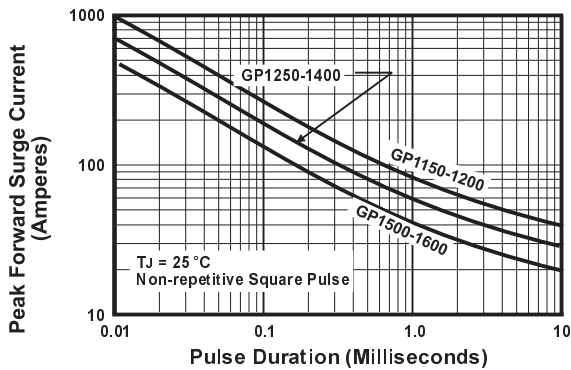

FIGURE 6. PEAK FORWARD SURGE CURRENT

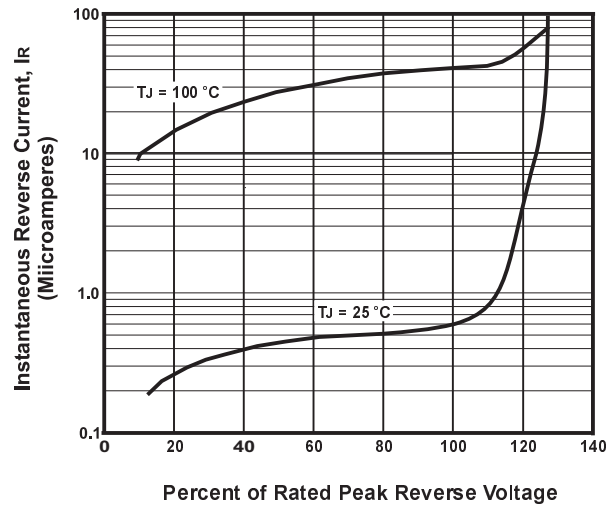

FIGURE 4. TYPICAL REVERSE CHARACTERISTICS

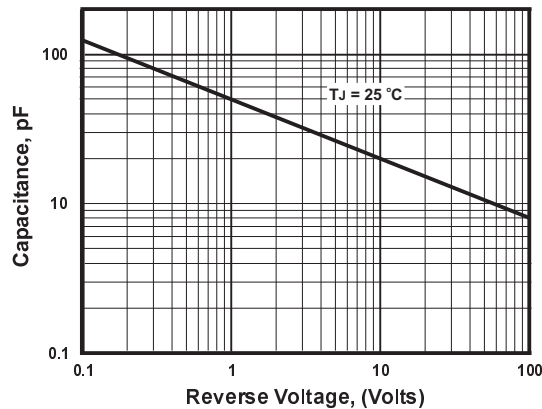

FIGURE 5. TYPICAL JUNCTION CAPACITANCE PER DIODE