

# HIGH VOLTAGE FAST RECOVERY DIODES

## FEATURES

- PROPRIETARY *SOFT GLASS*<sup>®</sup> JUNCTION PASSIVATION FOR SUPERIOR RELIABILITY AND PERFORMANCE
- VOID FREE VACUUM DIE SOLDERING FOR MAXIMUM MECHANICAL STRENGTH AND HEAT DISSIPATION (Solder Voids: Typical  $\leq 2\%$ , Max.  $\leq 10\%$  of Die Area)
- EXTREMELY LOW LEAKAGE AT HIGH TEMPERATURES
- LOW FORWARD VOLTAGE DROP
- HIGH CURRENT CAPABILITY

## MECHANICAL DATA

- Case: JEDEC DO-41 molded epoxy (U/L Flammability Rating 94V-0)
- Terminals: Plated axial leads
- Soldering: Per MIL-STD 202 Method 208 guaranteed
- Polarity: Color band denotes cathode
- Mounting Position: Any
- Weight: DO-41 - 0.012 Ounces (0.34 Grams)

**RoHS COMPLIANT**

## MECHANICAL SPECIFICATION

ACTUAL SIZE OF DO-41 PACKAGE

SERIES RGP1120 - RGP1500

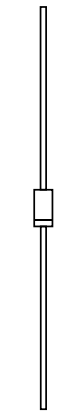

DO-41

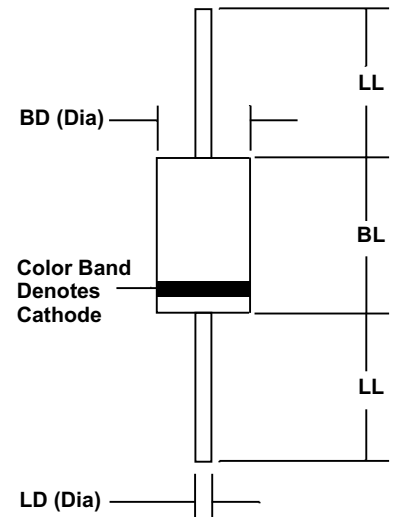

Sym	Minimum		Maximum	
	In	mm	In	mm
BL	0.160	4.1	0.205	5.2
BD	0.103	2.6	0.107	2.7
LL	1.00	25.4		
LD	0.028	0.71	0.034	0.86

## MAXIMUM RATINGS & ELECTRICAL CHARACTERISTICS

Ratings at 25 °C ambient temperature unless otherwise specified.  
 Single phase, half wave, 60Hz, resistive or inductive load.  
 For capacitive loads, derate current by 20%.

PARAMETER (TEST CONDITIONS)	SYMBOL	RATINGS					UNITS			
		RGP 1120	RGP 1150	RGP 1180	RGP 1200	RGP 1250		RGP 1300	RGP 1400	RGP 1500
Series Number										
Maximum DC Blocking Voltage	V <sub>RM</sub>	1200	1500	1800	2000	2500	3000	4000	5000	
Maximum RMS Voltage	V <sub>RMS</sub>	840	1050	1260	1400	1750	2100	2800	3500	
Maximum Peak Recurrent Reverse Voltage	V <sub>RRM</sub>	1200	1500	1800	2000	2500	3000	4000	5000	
Average Forward Rectified Current @ T <sub>A</sub> = 50 °C (Lead length = 0.375 in. (9.5 mm))	I <sub>O</sub>	800		400		200				
Peak Forward Surge Current (8.3 mSec single half sine wave superimposed on rated load)	I <sub>FSM</sub>	30		20		10		AMPS		
Maximum Forward Voltage at Rated Forward Current	V <sub>FM</sub>	2.5		4.5		6.5		VOLTS		
Maximum Average DC Reverse Current At Rated DC Blocking Voltage @ T <sub>A</sub> = 25°C	I <sub>RM</sub>	1.0					μA			
Maximum Reverse Recovery Time (I <sub>F</sub> =0.5A, I <sub>R</sub> =1A, I <sub>RR</sub> =0.25A)	T <sub>RR</sub>	500					nS			
Operating and Storage Temperature Range	T <sub>J</sub> , T <sub>STG</sub>	-65 to +125			-65 to +150			°C		

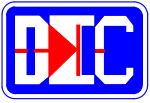

# HIGH VOLTAGE FAST RECOVERY RECTIFIERS

## RATING & CHARACTERISTIC CURVES FOR SERIES RGP1120 - RGP1500

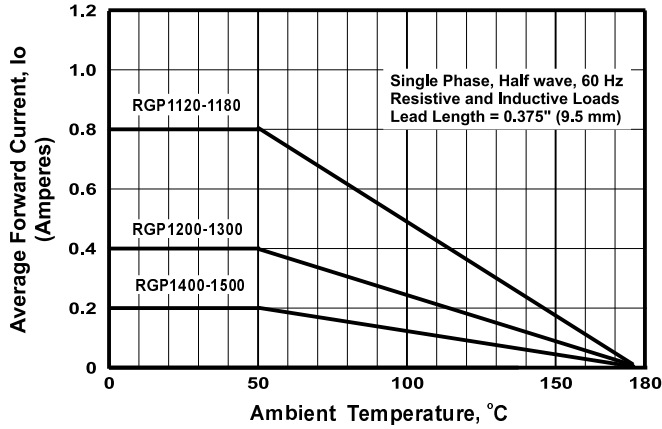

FIGURE 1. FORWARD CURRENT DERATING CURVE

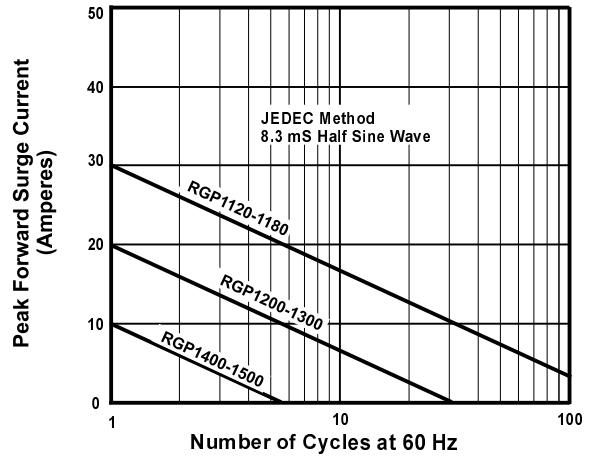

FIGURE 2. MAXIMUM NON-REPETITIVE SURGE CURRENT

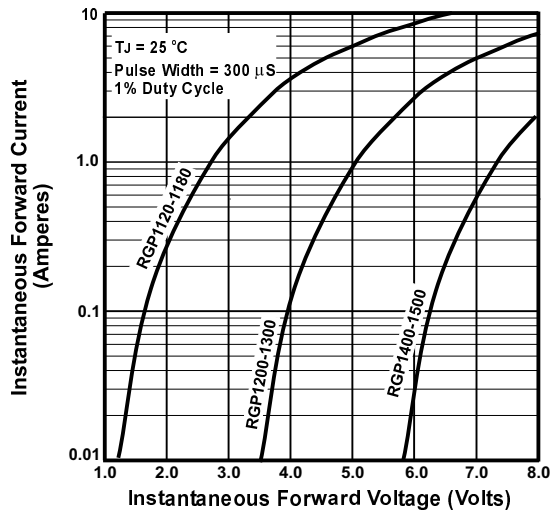

FIGURE 3. TYPICAL FORWARD CHARACTERISTIC

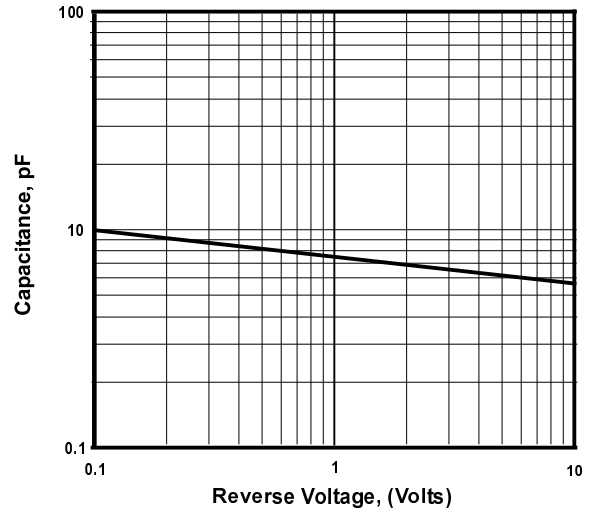

FIGURE 4. TYPICAL JUNCTION CAPACITANCE

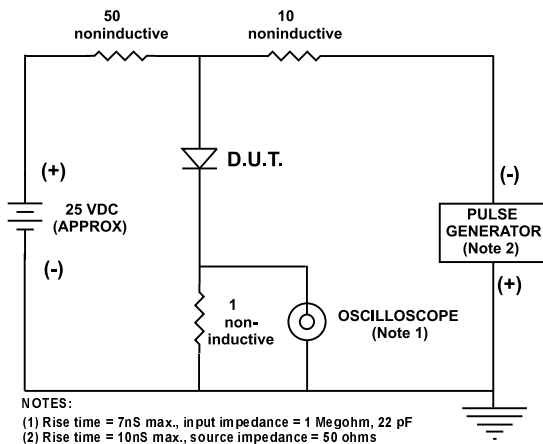

FIGURE 5. REVERSE RECOVERY TEST SETUP AND TIME CHARACTERISTIC