

1 AMP SCHOTTKY BARRIER RECTIFIERS

FEATURES

- Metal semiconductor junction with guard ring
- Epitaxial Construction
- Low forward voltage drop
- High current capacity
- For use in low voltage, high frequency inverters, free wheeling, and polarity protection applications
- **RoHS COMPLIANT**

MECHANICAL DATA

- Case: JEDEC DO-41, molded epoxy (U/L Flammability Rating 94V-0)
- Terminals: Plated axial leads
- Soldering: Per MIL-STD 202 Method 208 guaranteed
- Polarity: Color band denotes cathode
- Mounting Position: Any
- Weight: 0.012 Ounces (0.34 Grams)

MECHANICAL SPECIFICATION

ACTUAL SIZE OF
DO-41 PACKAGE

SERIES SK102 - SK110

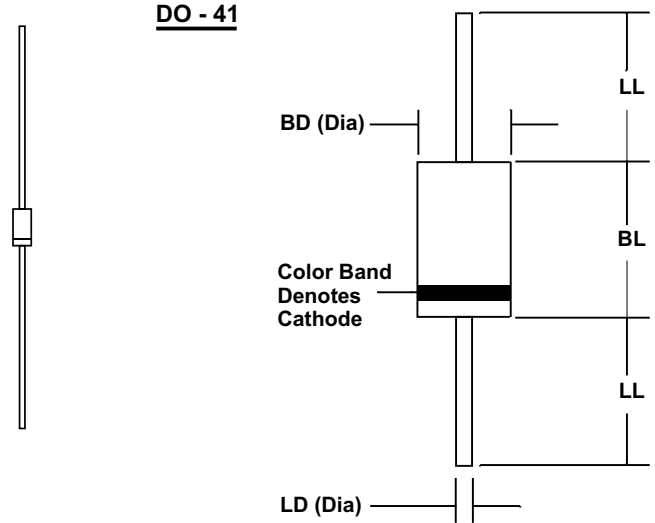

Sym	Minimum		Maximum	
	In	mm	In	mm
BL	0.160	4.1	0.205	5.2
BD	0.103	2.6	0.107	2.7
LL	1.00	25.4		
LD	0.028	0.71	0.034	0.86

MAXIMUM RATINGS & ELECTRICAL CHARACTERISTICS

Ratings at 25 °C ambient temperature unless otherwise specified.
 Single phase, half wave, 60Hz, resistive or inductive load.
 For capacitive loads, derate current by 20%.

PARAMETER (TEST CONDITIONS)	SYMBOL	RATINGS						UNITS
		SK102	SK104	SK106	SK107	SK108	SK110	
Series Number								
Maximum DC Blocking Voltage	V _{RM}	20	40	60	70	80	100	VOLTS
Maximum RMS Voltage	V _{RMS}	14	28	42	49	56	70	
Maximum Peak Recurrent Reverse Voltage	V _{RRM}	20	40	60	70	80	100	
Average Forward Rectified Current @ T _L = 90 °C (T _L measured on cathode lead, 1/32 in. from case)	I _O	1						AMPS
Peak Forward Surge Current (8.3mS single half sine wave superimposed on rated load)	I _{FSM}	40						
Maximum Forward Voltage at 1 Amp DC	V _{FM}	0.5		0.7		0.8		VOLTS
Maximum Average DC Reverse Current At Rated DC Blocking Voltage (Note 1)	I _{RM}	@ T _L = 25 °C 0.5			@ T _L = 100 °C 0.1			mA
Typical Thermal Resistance, Junction to Ambient	R _{θJA}	15						°C/W
Typical Junction Capacitance (Note 2)	C _J	110						pF
Junction Operating Temperature Range	T _J	-65 to +125				-65 to +150		°C
Storage Temperature Range	T _{STG}	-65 to +150						

NOTES: (1) Lead temperature reference is cathode lead 1/32 in from case.
 (2) Measured at 1MHz & applied reverse voltage of 4 volts

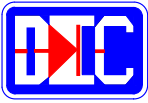

1 AMP SCHOTTKY BARRIER RECTIFIERS

RATING & CHARACTERISTIC CURVES FOR SERIES SK102 - SK107 and SERIES SK108 - SK110

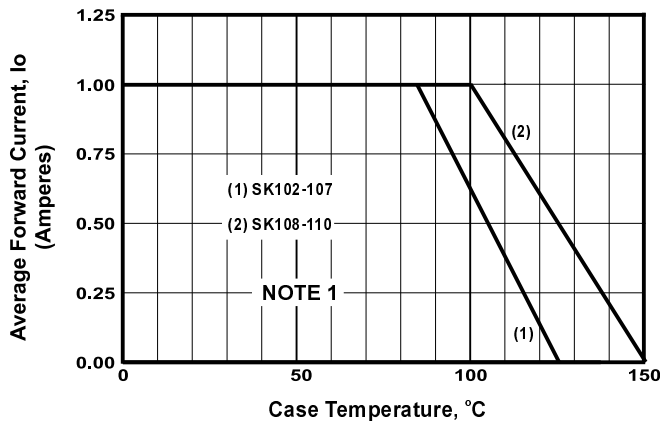

FIGURE 1. FORWARD CURRENT DERATING CURVE

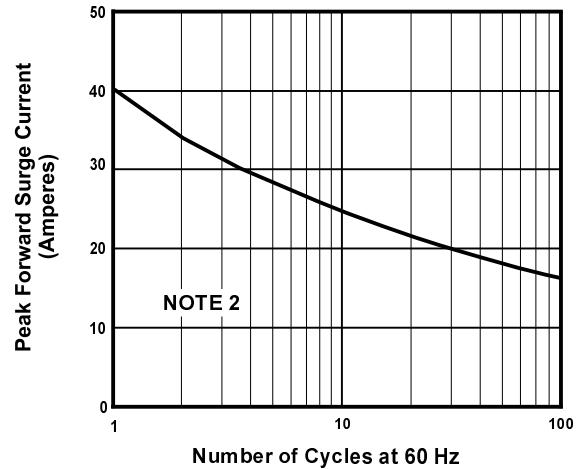

FIGURE 2. MAXIMUM NON-REPETITIVE SURGE CURRENT

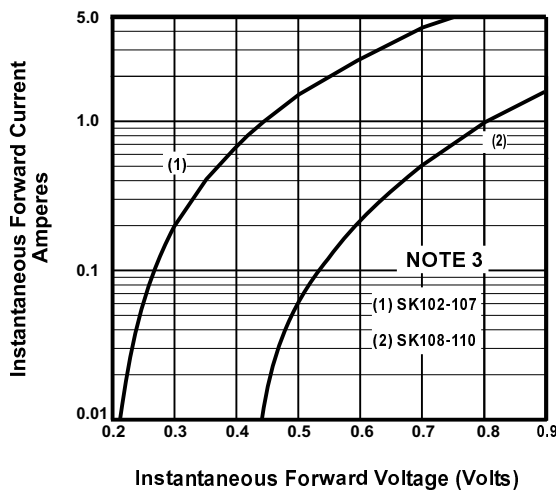

FIGURE 3. TYPICAL FORWARD CHARACTERISTICS

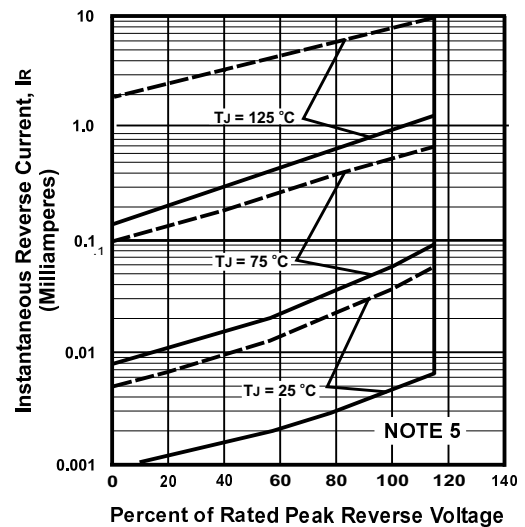

FIGURE 4. TYPICAL REVERSE CHARACTERISTICS

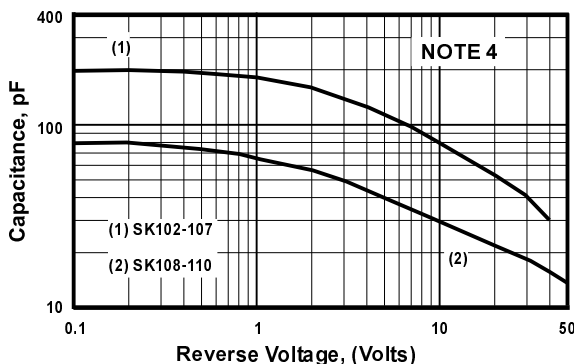

FIGURE 5. TYPICAL JUNCTION CAPACITANCE

NOTES

- (1) Single Phase, Half Wave, 60 Hz, Resistive or Inductive Load, 0.375" (9mm) Lead Length
- (2) JEDEC Method, 8.3 mSec. Single Half Sine Wave, $T_c = 95^\circ\text{C}$
- (3) $T_J = 25^\circ\text{C}$, Pulse Width = 300 μSec , 2.0% Duty Cycle
- (4) $T_J = 25^\circ\text{C}$, $f = 1\text{MHz}$, $V_{SIG} = 50\text{ mV P-P}$
- (5) Legend for Figure 4, Typical Reverse Characteristics:

----- SK102-107

———— SK108-110